

Description

The MSL-174G, a GREEN source Chip LED device, is designed in an industry standard package suitable for SMT assembly method. It utilizes GaP on GaP LED chip technology and water clear epoxy package.

Applications

- Small Size
- Industry Standard Footprint(0805)
- Compatible with IR Solder process
- Available in 8 mm Tape on 7"(178mm)

Diameter Reels

Features

- Push-Button Backlighting
- LCD Backlighting
- Symbol Backlighting
- Front Panel Indicator

Absolute Maximum Ratings

@ T_A=25°C

Parameter	Symbol	Maximum Rating	Unit
Peak Forward Current(1/10 Duty Cycle@1KHz)	I _{FP}	120	mA
DC Forward Current	I _F	25	mA
Power Dissipation	P _D	70	mW
Reverse Voltage	V _R	5	V
Operating Temperature Range	T _{OPR}	-20°C to +80°C	
Storage Temperature Range	T _{STG}	-30°C to +100°C	

Package Dimensions

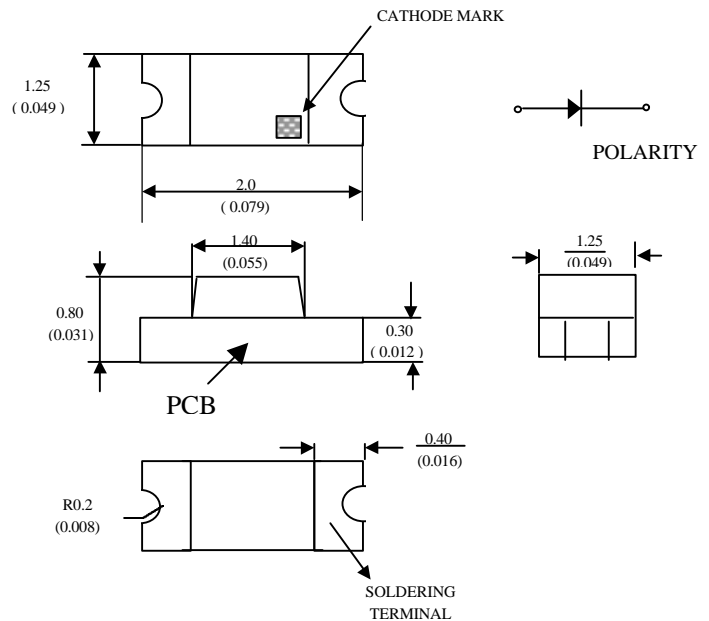

Recommended Solder Patterns

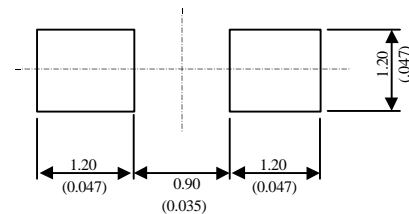

NOTE:

1. All dimensions are in millimeter (inches)
2. Tolerance is ± 0.1mm (.004") unless otherwise specified.

Optical-Electrical Characteristics

@ T_A=25°C

Parameter	Test Conditions	Symbol	Min .	Typ .	Max .	Unit .
Luminous Intensity	I _F =20mA	I _V	3.0	6.5	-	mcd
Forward Voltage	I _F =20mA	V _F	-	2.3	2.6	V
Reverse Current	V _R =5V	I _R	-	-	10	μA
Peak/Dominant Wavelength	I _F =20mA	λ _p /λ _d	-	568/570	-	nm
Spectral Linewidth	I _F =20mA	Δλ	-	30	-	nm
Viewing Angle	I _F =20mA	2θ _{1/2}	-	130	-	deg.

Typical Optical-Electrical Characteristic Curves

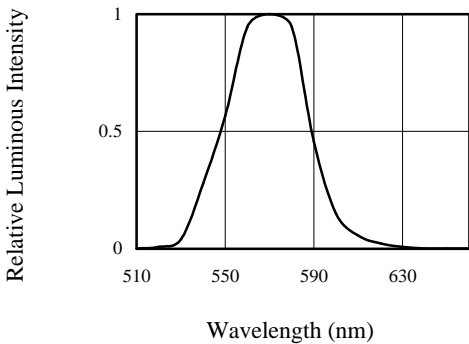

FIG.1 RELATIVE INTENSITY LUMINOUS VS. WAVELENGTH

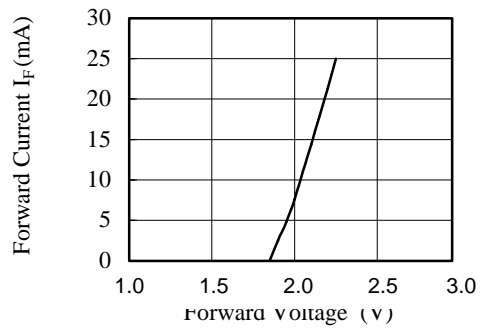

FIG.2 FORWARD CURRENT VS. FORWARD VOLTAGE.

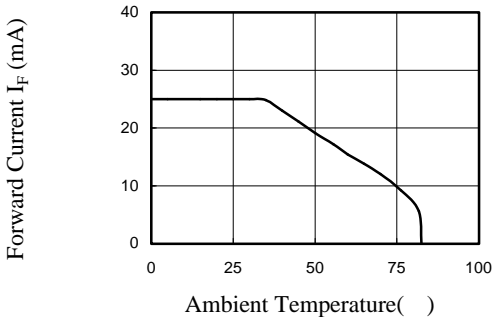

FIG. 3 FORWARD CURRENT VS. AMBIENT TEMPERATURE.

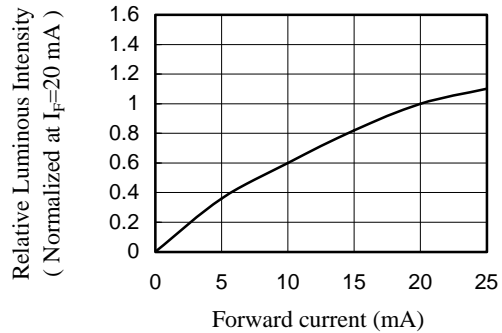

FIG. 4 RELATIVE LUMINOUS INTENSITY VS. FORWARD CURRENT.

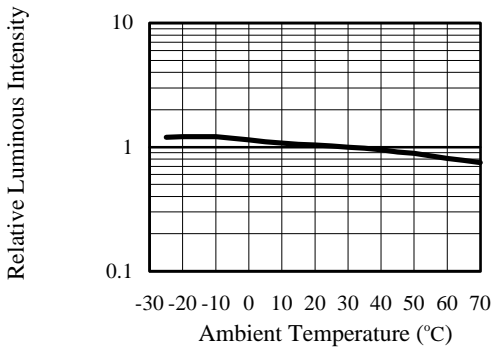

FIG.5 LUMINOUS INTENSITY VS. AMBIENT TEMPERATURE

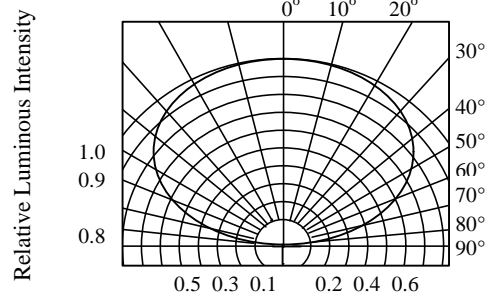

FIG.6 RADIATION DIAGRAM